

# VDI - A1 Rectangular Soft Blank - VDI 30

[https://www.kfh-hermann.de/shop/product\\_info.php?products\\_id=389&XTCSid=n7eemf1jolajl8itk84fees403](https://www.kfh-hermann.de/shop/product_info.php?products_id=389&XTCSid=n7eemf1jolajl8itk84fees403)



## Illustration



([https://www.kfh-hermann.de/shop/shop/images/product\\_images/original\\_images/bilder\\_B47-A1.jpg?XTCSid=n7eemf1jolajl8itk84fees403](https://www.kfh-hermann.de/shop/shop/images/product_images/original_images/bilder_B47-A1.jpg?XTCSid=n7eemf1jolajl8itk84fees403))

## Drawing

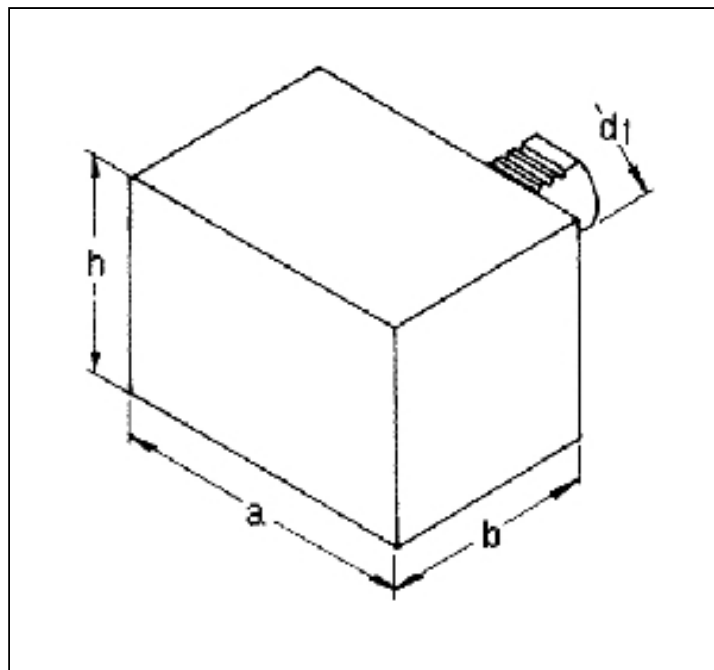

([https://www.kfh-hermann.de/shop/shop/images/product\\_images/original\\_images/skizzen\\_Z47-A1.jpg?XTCSid=n7eemf1jolajl8itk84fees403](https://www.kfh-hermann.de/shop/shop/images/product_images/original_images/skizzen_Z47-A1.jpg?XTCSid=n7eemf1jolajl8itk84fees403))

## Technical information

<b>Usage:</b>	blank bar for production of special toolholders
<b>Customs tariff code:</b>	84 661 03 1

## Variants

Product No.	d1	a	h	b	weight in kg	Stock 12.02, 08:14	Net-price
VDI A1 30x130	30	130	76	85	6,8	7	<b>Please start an inquiry</b>

Stock data from 2024-02-12 08:14:41

## Kontakt

KARL HERMANN GmbH | Varnbülerstrasse 10 - 12 | D - 71229 Leonberg | | Tel.: +49 (0)7152 / 93992-0 | Fax: +49 (0)7152 / 93992-4 | E-Mail: [verkauf@kfh-hermann.de](mailto:verkauf@kfh-hermann.de) | Internet: <http://www.kfh-hermann.de>

2024-02-13 11:42:22, [https://www.kfh-hermann.de/shop/product\\_info.php?products\\_id=389&XTCSid=n7eemf1jolajl8itk84fees403](https://www.kfh-hermann.de/shop/product_info.php?products_id=389&XTCSid=n7eemf1jolajl8itk84fees403)