

Clindric+Weldonshaft - Drill-chuck with Weldon-shaft - Weldon Dia 40



https://www.kfh-hermann.de/shop/product_info.php?products_id=286&XTCsid=n7eemf1jolajl8itk84fees403

Illustration



(https://www.kfh-hermann.de/shop/shop/images/product_images/original_images/bilder_B134_Wel.jpg
XTCsid=n7eemf1jolajl8itk84fees403)

Drawing

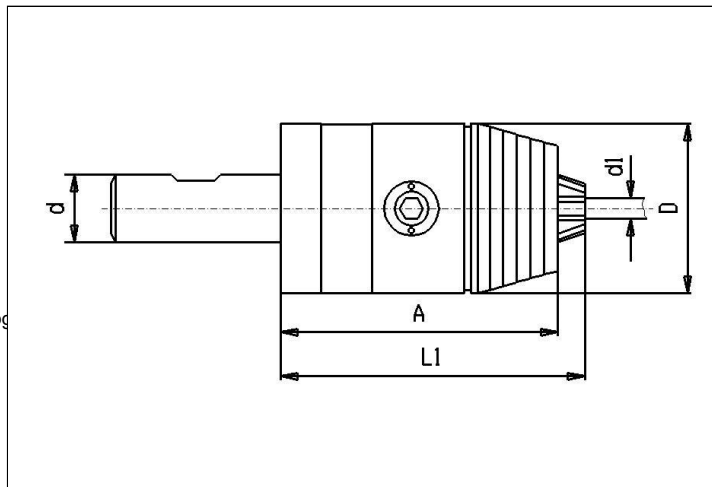

(https://www.kfh-hermann.de/shop/shop/images/product_images/original_images/skizzen_Z134_Wel.j
XTCsid=n7eemf1jolajl8itk84fees403)

Technical information

Usage:	For clamping of toolings with zylindrical shafts Permissible rotating speed: Clamping range 0,5 - 8 mm max. 25.000 U/min Clamping range 1 - 13 mm max. 20.000 U/min Clamping range 3 - 16 mm max. 15.000 U/min To fit these rotating speed
Scope of delivery:	with spanner
Accuracy:	Runout max. 30µm
Customs tarif code:	84 661 02 0

Variants

Product No.	d1	A	d	D	Stock 12.02, 08:14	Net-price
G134 Wel 40x13	1-13	82	40	50	on inquiry	Please start an inquiry
G134 Wel 40x16	3-16	87	40	57	on inquiry	Please start an inquiry

Stock data from 2024-02-12 08:14:41

Kontakt

KARL HERMANN GmbH | Varnbülerstrasse 10 - 12 | D - 71229 Leonberg | | Tel.: +49 (0)7152 / 93992-0 | Fax: +49 (0)7152 / 93992-4 | E-Mail: verkauf@kfh-hermann.de | Internet: <http://www.kfh-hermann.de>

2024-02-13 11:32:34, https://www.kfh-hermann.de/shop/product_info.php?products_id=286&XTCsid=n7eemf1jolajl8itk84fees403